

EXSTREAMER

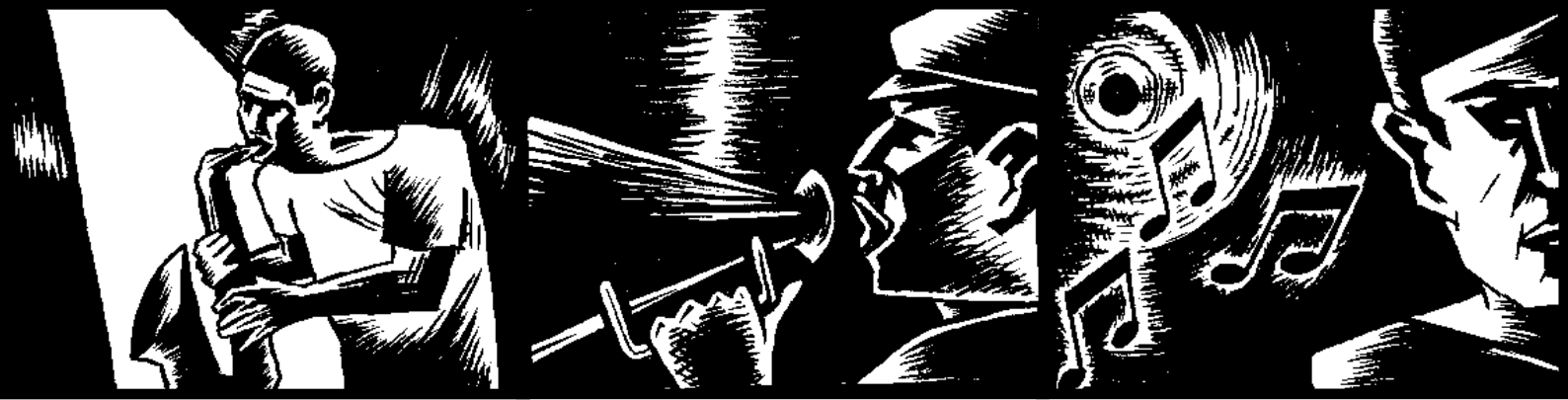

EXSTREAMER 200

Network audio decoder for
commercial applications and
custom home installations



Quick Install Guide Version 1.0

For Standard Firmware



Package content

- a Exstreamer 200
- b Power supply

Front view



- 1 Reset button
Press this button shortly to reset the device.
If you press it until the red light flashes (about 5 seconds) the device will be reset to factory defaults.
- 2 USB 1.1 interface (only supported in Streaming Client firmware available on www.barix.com)
- 3 Green LED for status display
- 4 Red LED for status display
- 5 Headphone out

Installation

STEP 1

Plug a network cable (e) into the network port (A) of the Exstreamer and the other end into your hub or switch. You can also use a crossover network cable (not included) for a direct connection to your PC.

STEP 2

Plug an earphone (c) into the headphone output (5) and put it in your ear. Get a pen and paper ready to write down the IP address that will be announced in step 4.

STEP 3

Plug the power supply (b) into the power jack (D) of the device and the other end into the power outlet of the wall.

STEP 4

The Exstreamer will now search for a DHCP server to get an IP address and announce it over the earphone.

Example: 192.168.0.12 (Voice: one nine two...)

Make sure you write this IP address down.

Cable Set AUDIO (not included)

- c Earphone
- d RCA stereo cable
- e Network cable
- f Serial cable

Rear view

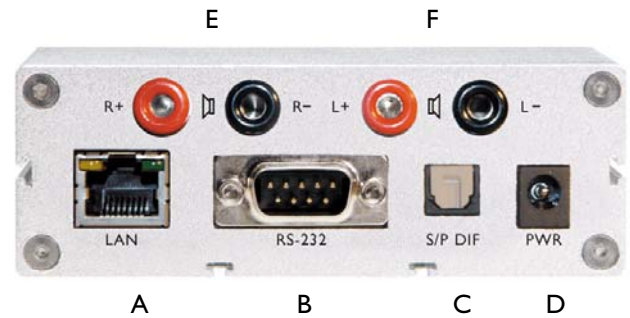

- A RJ45 for LAN 10/100 Half/Full duplex
- B DSub9 male, Serial port (RS-232)
- C Optical digital output (S/P DIF)
- D Power in
- E Right speaker output
- F Left speaker output

If no DHCP server is found then our IPzator function will search the network for a free IP address (this could take up to 5 minutes). If the IP address is not announced check if the green LED (right LED on top of network port A) is lit. If it stays dark check your network cabling. If the front LEDs (3 and 4) stay dark check the power cabling (step 3).

If it still fails revert the device to factory defaults by pressing the Reset button for about 5 seconds while the Exstreamer is powered.

STEP 5

Plug the speaker cable of the right speaker into the speaker output (E) and the left speaker into the left output (F). Ensure the right polarity on both channels to prevent bad sound due to phase cancellation (marked wire on same color for left and right channel)

Your Exstreamer is now ready to start working. We recommend, however, that you set a Static IP address. See next pages on how to do this or download the user manual from www.barix.com.

Network configuration by web browser

STEP 1

Open your web browser.

STEP 2

Enter the IP address of the Exstreamer and press Enter.
Example: 192.168.0.12

STEP 3

Click on the Config link: 



STEP 4

Enter an IP address into the 4 IP address fields. At default it is 0.0.0.0 for automatic. You can use the address that was announced by the Exstreamer.

STEP 6

In normal operating conditions leave the Netmask as is.

STEP 5

The Gateway, primary and alternative DNS IP addresses as well as Sonic IP can be left at default for now.

STEP 7

Hit the Apply button to save all changes. The Exstreamer will reboot with the Static IP address.

Please continue with section "Next steps" on last page.

Network configuration using supplied serial cable

STEP 1

Open a Terminal program.

STEP 2

Go to the settings menu of the terminal program and adjust the following settings:
Baud rate 9600 bit/sec, 8 Data Bits, no Parity, 1 Stop Bit

STEP 3

Unplug the power supply of the Exstreamer.

STEP 4

Connect the supplied serial cable to your PC's COM port and to the serial port of the Exstreamer.

STEP 5

Keep the Reset button pushed and plug in the power supply. Release the Reset button as soon as you see the following screen:

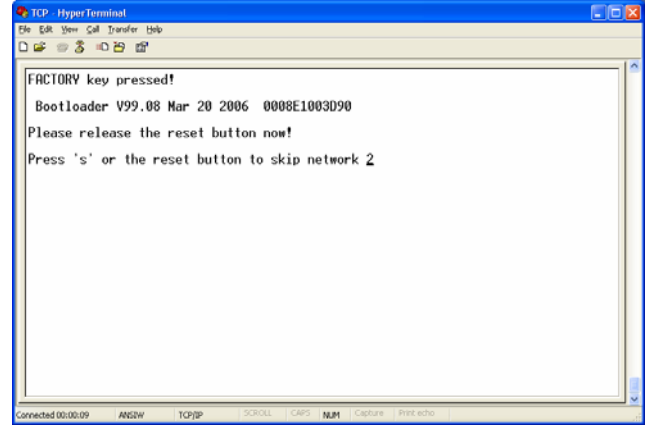

STEP 6

Hit <s> to skip network discovery if not connected to a network and the following screen appears:

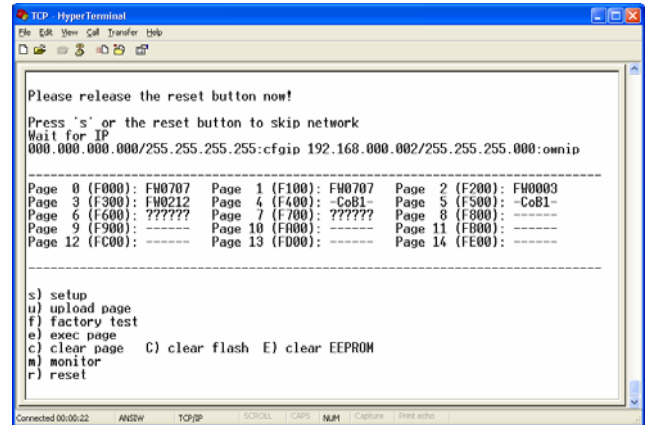

STEP 7

Hit <s> to get to the Exstreamer setup.

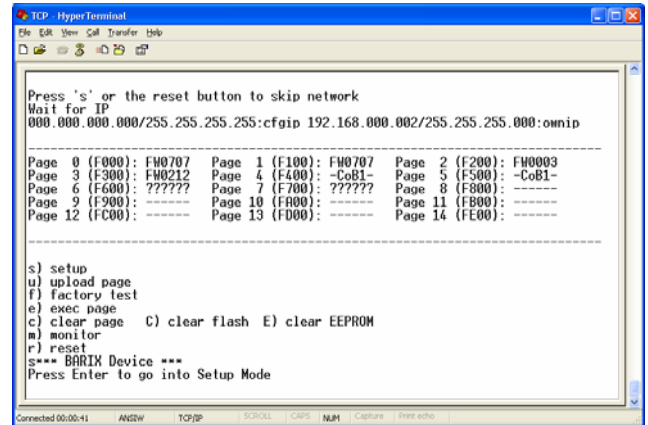

STEP 8

Hit <enter> to enter the Exstreamer setup mode.

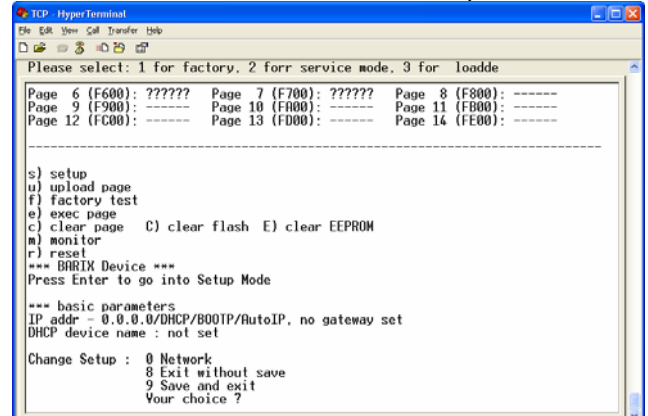

STEP 9

Type in <0> and hit <enter> to enter the Network configuration. Enter all requested values:

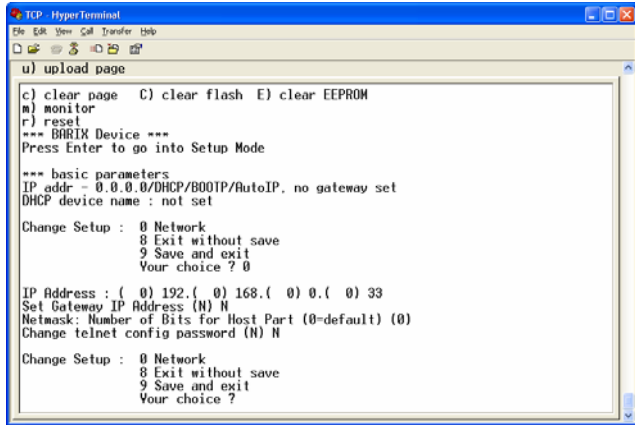

STEP 10

Type in <9> and hit <enter> to save the Network configuration.

Please continue with section “Next steps”.

Network configuration using telnet

STEP 1

Unplug the power supply of the Exstreamer.

STEP 2

Keep the Reset button pushed and plug in the power supply. Release the Reset button after 5 seconds.

STEP 3

Run a command session. Type telnet in the run window with the IP address announced by Sonic IP on port 9999. Example: telnet 192.168.0.12 9999

You will see the following screen:

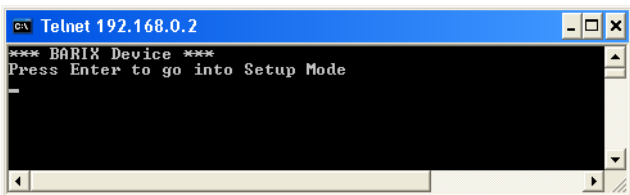

Hit <enter> to access the Exstreamer in the setup mode.

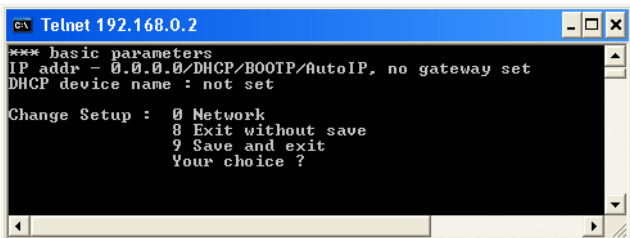

STEP 9

Type in <0> and hit <enter> to enter the Network configuration. Enter all requested values.

STEP 10

Type in <9> and hit <enter> to save the Network configuration.

Next steps

STEP 1

Download the user manual from www.barix.com.

STEP 2

Check the section “Updating the device”.

STEP 3

Check the section “IR Remote control” on how to install the IR serial receiver.

STEP 4

Check out the Barix user forum on www.barix.com for additional information.

Alternative “Streaming Client” firmware

Please visit www.barix.com and download the “Streaming Client Update Package”. This alternative firmware supports WMA and MP3 streaming (http, UDP, RTP) with automatic failover and USB flash memory playback.

Support

For support please contact your local dealer or visit www.barix.com.

© Barix AG 6/2006, all rights reserved.

All information is subject to change without notice.

All mentioned trademarks belong to their respective owners and are used for reference only.

Barix, Exstreamer, SonicIP and IPzator are trademarks of Barix AG, Switzerland, and are registered in certain countries.

For information about our products, manuals, technical documentations and latest version of firmware please visit www.barix.com.

Barix AG

Seefeldstrasse 303

8008 Zürich

SWITZERLAND

www.barix.com